



The Infinite Bandwidth Company™

MIC2514

IttyBitty™ Integrated High-Side Switch

Final Information

General Description

The MIC2514 is an integrated high-side power switch that consists of a TTL compatible input and protected P-channel MOSFET. The MIC2514 can be used instead of a separate high-side driver and MOSFET in many low-voltage applications.

The MIC2514 switches voltage ranging from 3V to 13.5V and delivers more than 400mA continuous current. A slow turn-on feature prevents high inrush current when switching capacitive loads. The internal control circuitry is powered from the unswitched 3V to 13.5V input.

Current limiting is internally fixed at approximately 1.9A and requires no external components.

Thermal shutdown turns off the output if the die temperature exceeds approximately 170°C.

The MIC2514 is available in the 5-lead SOT-23-5 package with a temperature range of -40°C to +85°C.

Features

- MOSFET on-resistance
1.5Ω typical at 5V
0.95Ω typical at 12V
- 3V to 13.5V input
- 25μA typical on-state supply current at 5V
- <1μA typical off-state supply current at 5V
- Current limit
- Thermal shutdown
- Slow turn-on

Applications

- 3.3V to 13.5V power management

Ordering Information

Part Number	Temperature Range	Package
MIC2514BM5	-40°C to +85°C	SOT-23-5

Pin Configuration

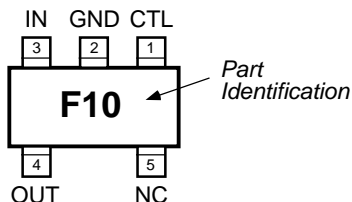

5-Lead SOT-23-5 (M5)

Typical Application

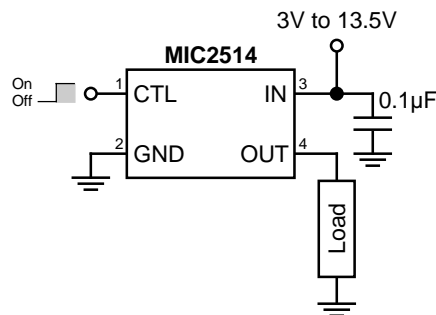

High-Side Power Switch

Pin Description

Pin Number	Pin Name	Pin Function
1	CTL	Control (Input): Noninverting TTL compatible control input. High = on, low = off.
2	GND	Ground
3	IN	Supply Input: Output MOSFET source. Also supplies IC's internal circuitry. Connect to supply.
4	OUT	Switch Output: Output MOSFET drain. Connect to switched side of load.
5	NC	Not internally connected. Connect to ground plane for lowest package thermal resistance.

Absolute Maximum Ratings

Supply Voltage (V_{IN})	+20V
Output Current (I_{OUT})	Internally Limited
Control Input (V_{CTL})	-0.3V to 15V
Storage Temperature (T_A)	-65°C to +150°C

Operating Ratings

Supply Voltage (V_{IN})	+3V to +13.5V
Ambient Operating Temperature (T_A)	-40°C to +85°C
Thermal Resistance	
(θ_{JA})	220°C/W
(θ_{JC})	130°C/W

Electrical Characteristics

$V_{IN} = +5V$; $T_A = 25^\circ C$, except **bold** values indicate $-40^\circ C \leq T_A \leq 85^\circ C$, **Note 1**; unless noted.

Parameter	Condition	Min	Typ	Max	Units
Supply Current	$V_{CTL} = \text{logic 0}, V_{IN} = 5V$		0.6	10	μA
	$V_{CTL} = \text{logic 0}, V_{IN} = 13.5V$		2.0	25	μA
	$V_{CTL} = \text{logic 1}, V_{IN} = 3V$ $V_{CTL} = \text{logic 1}, V_{IN} = 5V$ $V_{CTL} = \text{logic 1}, V_{IN} = 13.5V$		10 25 95	20 40 200	μA μA μA
Control Input Voltage	$V_{CTL} = \text{logic 0}, 3V \leq V_{IN} \leq 13.5V$	0		0.8	V
	$V_{CTL} = \text{logic 1}, 3V \leq V_{IN} \leq 5V$ $V_{CTL} = \text{logic 1}, 5V \leq V_{IN} \leq 13.5V$	0.8 0.8	1.45 1.65	2.0 2.3	V V
Output MOSFET Resistance	$V_{IN} = 3V$		2.4	4.5	Ω
	$V_{IN} = 5V$		1.5	2.4 2.7	Ω Ω
	$V_{IN} = 12V$.95	1.5 1.7	Ω Ω
Current Limit Threshold	$V_{IN} = 3V$		0.5	1.5	A
	$V_{IN} = 5V$	1.0	1.4	2.0	A
	$V_{IN} = 12V$	1.2	1.9	2.5	A

General Note: Devices are ESD protected, however, handling precautions recommended.

Note 1: Devices production tested at 25°C, but Devices guaranteed over indicated temperature range.

Typical Characteristics

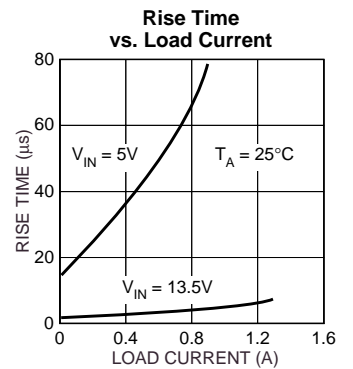
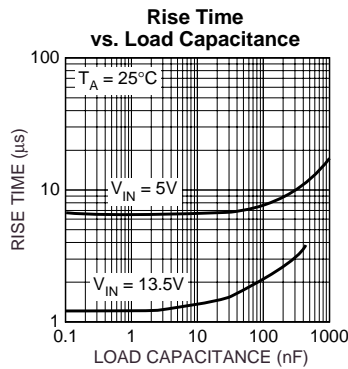
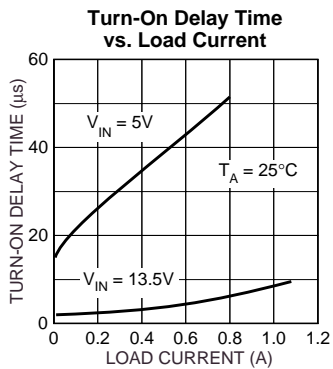
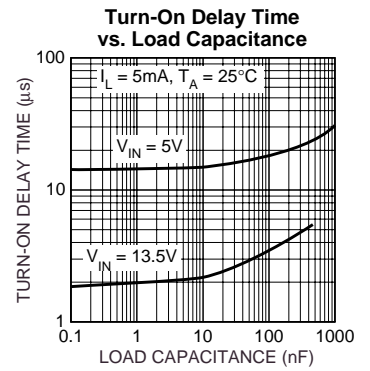
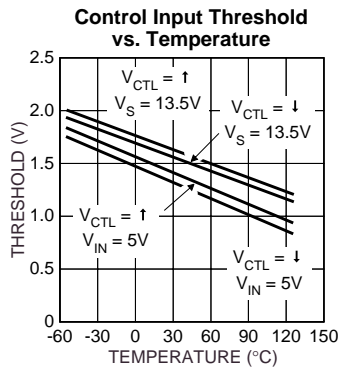
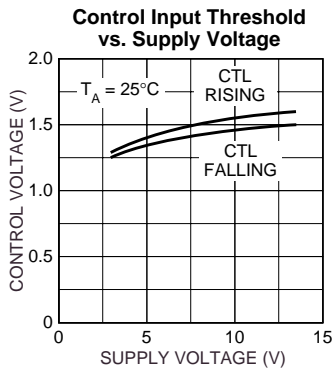
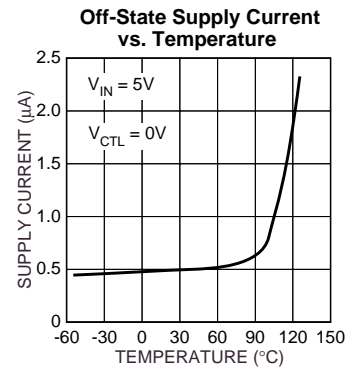
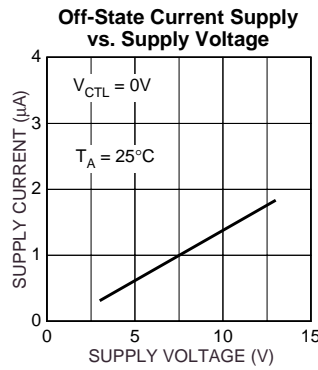
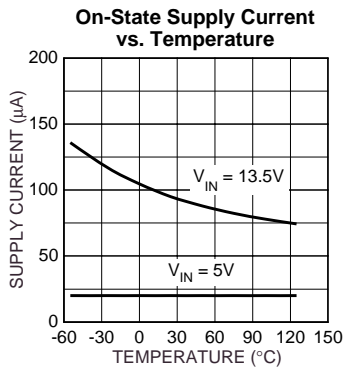
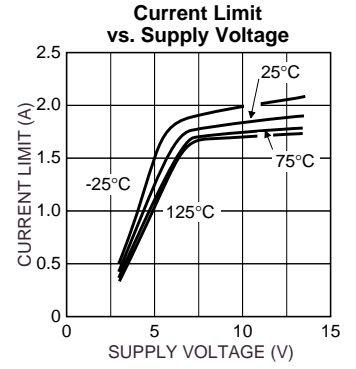
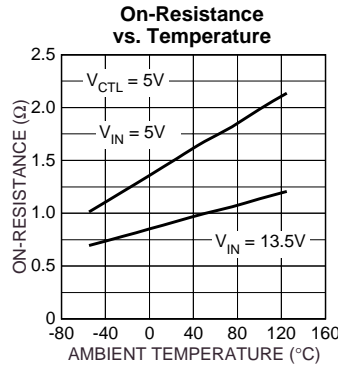
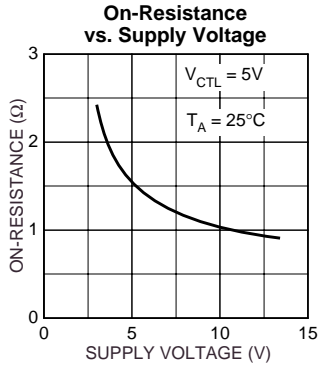

Typical Characteristics

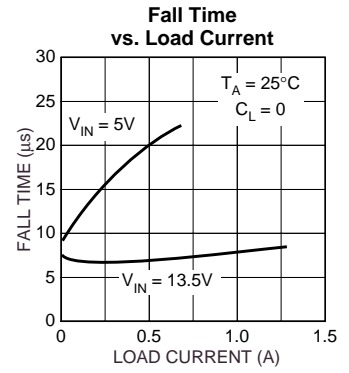
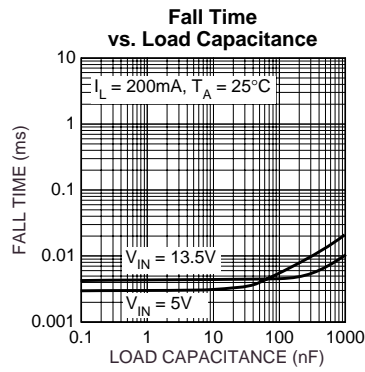
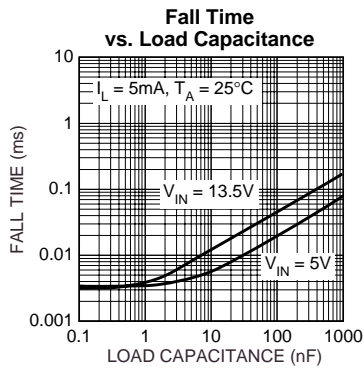
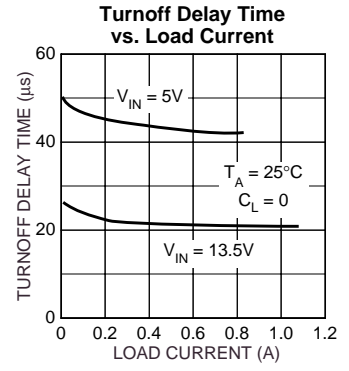
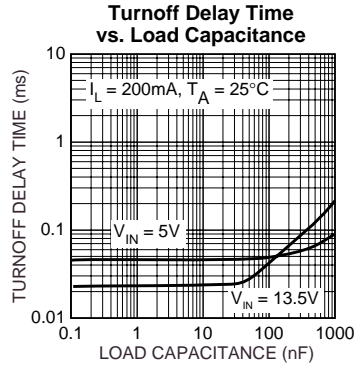
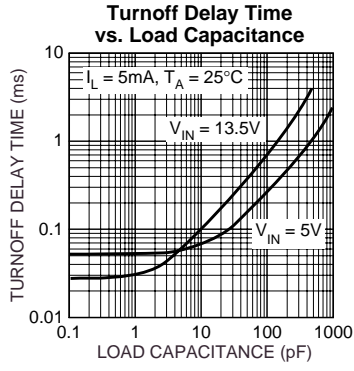

Functional Diagram

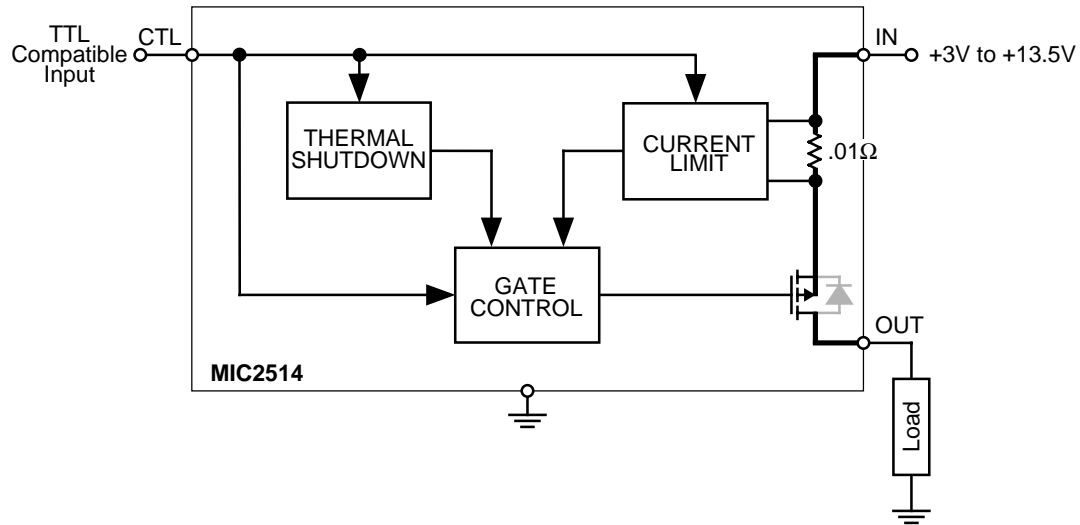

Functional Description

The MIC2514 is a noninverting high-side switch. A logic-high control input turns on the output transistor, and a logic-low turns off the output transistor. Fault conditions turn off the output transistor.

Control Input

Applying a logic-high input to CTL (control input) activates the thermal shutdown and gate control circuits. If there are no fault conditions, the output MOSFET turns on.

Gate Control

The gate control circuit applies the supply voltage to the output MOSFET gate, turning it off, or forces the MOSFET gate below the supply voltage, turning it on, as determined by CTL and thermal shutdown.

Input and Output

IN (input) is the supply connection to the logic circuitry and the source of the output MOSFET. OUT (output) is the drain of the output MOSFET. In a typical circuit, current flows through the switch from IN to OUT toward the load.

The output MOSFET has an intrinsic body diode which will conduct if OUT is forced to a higher voltage than IN.

Thermal Shutdown

Thermal shutdown turns off the output MOSFET if the die temperature exceeds approximately 170°C. Thermal shutdown releases the output after the die temperature decreases 10°C.

Current Limit

The current limit is preset internally. The preset level prevents damage to the output MOSFET but allows a typical current of 1.9A through the output MOSFET for the MIC2514. This current limit is sufficient to protect the bond wire and the output device from instantaneous high current. Package thermal ratings and power dissipation should be considered when determining safe continuous operating current. Output current is monitored by sensing the voltage drop across the output MOSFET source metal resistance.

Package Information

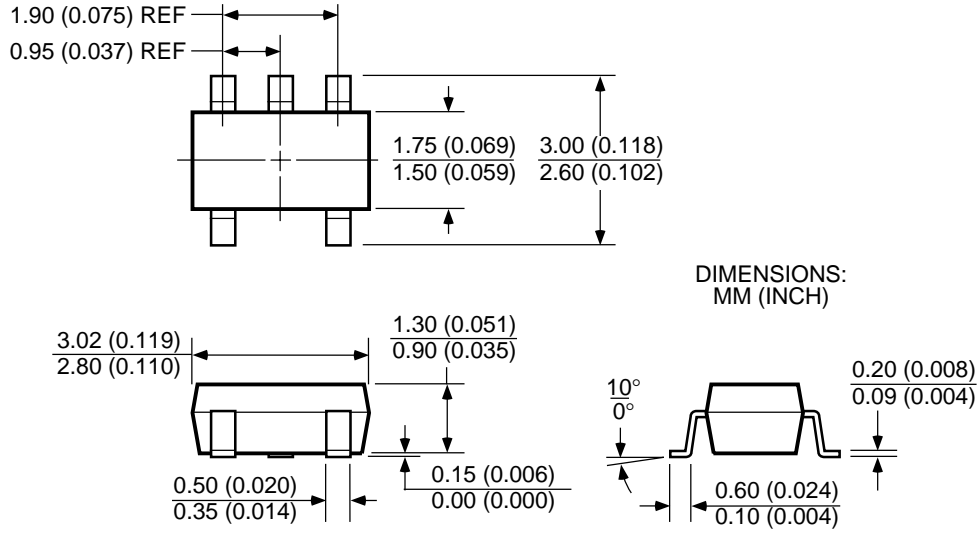

SOT-23-5 (M5)

MICREL INC. 1849 FORTUNE DRIVE SAN JOSE, CA 95131 USA

TEL + 1 (408) 944-0800 FAX + 1 (408) 944-0970 WEB <http://www.micrel.com>

This information is believed to be accurate and reliable, however no responsibility is assumed by Micrel for its use nor for any infringement of patents or other rights of third parties resulting from its use. No license is granted by implication or otherwise under any patent or patent right of Micrel Inc.

© 1997 Micrel Incorporated

This datasheet has been download from:

www.datasheetcatalog.com

Datasheets for electronics components.